

DRIP LINE FITTINGS

420BV-06-LS  Dripline x Oval Hose connector with valve 1-49 pcs..... \$ 1.50 50+ pcs..... \$ 1.30	CPT-06-LS  Dripline x dripline repair coupling 1-49 pcs..... \$.50 50+ pcs..... \$.40	400B-06-LSO  Dripline x Oval Hose connector. Also for 3/8" supply tubing. 1-49 pcs..... \$.40 50+ pcs..... \$.30
FTV5-LF  Dripline x layflat connector with valve. Use 16MM layflat punch tool. 1-49 pcs..... \$ 1.50 50+ pcs..... \$ 1.30	FHC-06-LSO  Dripline x layflat connector. Use 19MM layflat punch tool. 1-49 pcs..... \$.65 50+ pcs..... \$.50	FTA5-LF  Dripline x layflat connector. Use 16MM layflat punch tool. 1-49 pcs..... \$.65 50+ pcs..... \$.50
420-YV  Dripline x Oval Hose connector with valve 1-49 pcs..... \$ 1.50 50+ pcs..... \$ 1.30	YDC  Dripline x dripline repair coupling 1-49 pcs..... \$.50 50+ pcs..... \$.40	FTV-500  Dripline x dripline connector with valve \$ 1.50
ELL-06-LS  Dripline x dripline elbow \$ 1.50	TEE-06-LS  Dripline x dripline tee \$ 1.00	FHS-06-LSO  Dripline x garden hose connector \$ 1.75
420-50  Dripline x 1/2" MPT connector with valve 1-49 pcs..... \$ 1.50 50+ pcs..... \$ 1.30	MA-06-LS  Dripline x 1/2" mipt connector \$.60	CSP-06-LS  Dripline x 1/4" tubing connector \$.95
DRIP LINE END SLEEVE  Plug your row by folding drip tape several times and sliding sleeve over it. #END-SL..... \$.05	DRIP LINE END PLUG  #FTA5-END 1-49 pcs..... \$.50 50+ pcs..... \$.40	FCH-06-LSO  Dripline self-flush end \$ 1.25
OVAL HOSE GOOF PLUGS  #GP25 25 Plug..... \$.06 #GP40 40 Plug..... \$.20 #GP50 50 Plug..... \$.30 <small>#GP40 compatible with 420BV-06-LS and 400B-06-LS</small>	LAYFLAT GOOF PLUG  Large layflat goof plug #FHC-06-PLUG..... \$.80	GROMMETS for PVC pipe  Minimum dia. 1" PVC #400GRO 9/16" hole..... 400 barb..... \$.28 Minimum dia. 1 1/2" PVC #700GRO 13/16" hole..... 700 barb..... \$.39
STAKE WITH GAUGE  Punch hole in Oval Hose with #FP-420 and snap tubing adapter in place. #SG400..... \$ 7.50	SNAP ON GAUGE  Punch hole in Oval Hose with #FP-420 and snap gauge in place. #SN400..... \$ 6.00	OVAL HOSE TOOL  Punch tool for Oval Hose fitting installation. #FP-420..... \$ 10.00
INSTALLATION TOOL  T-handle hex tool for layflat fitting (#FTA5-LF) installation. #LF-INST..... \$ 8.50	LAYFLAT TOOL  #LFP-LS-16... 16 MMRed..... \$ 52.00 #LFP-LS-19... 19 MMGreen.. \$ 52.00	OVAL HOSE TOOL  Punch tool for 400B-06-LS installation. #DP400S..... \$ 19.50 #DP400S

TPA TUBING CONNECTOR

To mount, drill 29/64" hole in pipe.
 #TPA-1/4..... 1/4" x PVC..... \$.75
 #TPA-3/8..... 3/8" x PVC..... \$.75





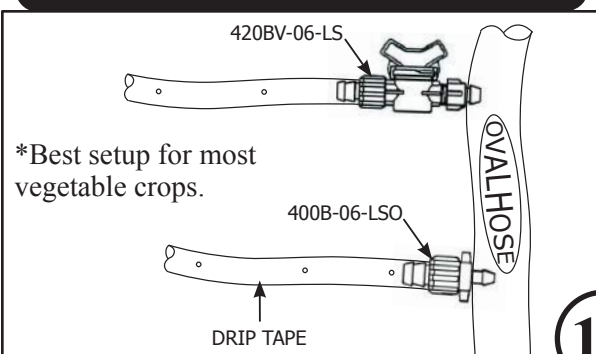

SUPPLY TUBING

#11190511..... 1/4" x 100'..... \$ 12.00
 #11190621..... 1/4" x 500'..... \$ 59.75
 #11190531..... 3/8" x 500'..... \$ 52.00

INSTALLATION LAYOUT



FITTING FOR 7/8" DRIP LINE

700B-09-LS  Dripline x Oval Hose connector \$.55	CPT-09-LS  Dripline x dripline repair coupling 1-49 pcs..... \$.65 50+ pcs..... \$.55
FTV7-LF  Dripline x layflat connector with valve \$ 1.50	FTA7-LF  Dripline x layflat connector \$.90
FTV7-400B  Dripline x Oval Hose con- nector with valve \$ 1.65	FTA7-END  Dripline end cap 1-49 pcs..... \$.55 50+ pcs..... \$.45