











RISER VALVE AND ACCESSORIES

FEMALE VALVE STUB	MALE VALVE STUB	WELD-ON STUB	REPLACEMENT COVER	STAINLESS ROD
				
P1726-01 .. 3" ... \$ 53.00 P1726-02 .. 4" .. \$ 68.00 P1726-04 .. 6" ... \$135.00 P1726-05 .. 8" ... \$268.00	P1729-01 .. 3" ... \$ 51.00 P1729-02 .. 4" .. \$ 62.00 P1729-04 .. 6" ... \$118.00 P1729-05 .. 8" ... \$280.00	P1724-01 .. 3" ... \$ 30.00 P1724-02 .. 4" .. \$ 33.00 P1724-04 .. 6" ... \$ 53.00 P1724-05 .. 8" ... \$152.00	P1059-01 ...3" .. \$ 4.90 P1060-01 ...4" . \$ 4.50 P1061-01 ...5" .. \$13.25 P1062-01 ...6" .. \$15.00	P2086-03 ... 3"-4" ... \$12.50 P2086-04 ... 5"-6" .. \$14.50 STEM WASHER  497-04 3"- 6" \$ 0.50
RISER TEE AND VALVE	RISER ELL AND VALVE	RISER TEE WITH ELBOW	RISER ELL WITH ELBOW	
IPS for PVC Pipe; Epoxycoated Steel * Gheen Risers Also Available P1220-05 4"x4"x4"x36" \$ 152.00 P1223-05 6"x6"x4"x36" \$ 169.00 P1224-05 6"x6"x6"x36" \$ 210.00 	IPS for PVC Pipe; Epoxycoated Steel * Gheen Risers Also Available P1252-05 4"x4"x36" \$ 137.00 P1254-05 6"x4"x36" \$ 158.00 P1255-05 6"x6"x36" \$ 196.00 P1257-05 8"x6"x36" \$ 235.00 	IPS for PVC Pipe; Epoxycoated Steel * Gheen Risers Also Available WITH MPT ELL PORT FOR AIR VENT P3571-03 4"x4"x4"x36" \$ 194.00 P3398-04 6"x6"x4"x36" \$ 208.00 P3348-04 6"x6"x6"x36" \$ 256.00 	IPS for PVC Pipe; Epoxycoated Steel * Gheen Risers Also Available WITH MPT ELL PORT FOR AIR VENT P3345-04 4"x4"x36" \$ 165.00 P3395-04 6"x4"x36" \$ 192.00 P3341-05 6"x6"x36" \$ 220.00 	

ALUMINUM IRRIGATION PIPE

"Z" PIPE



Galv. for underground PVC pipe with 3" air vent port and 3/4" pressure gauge port.

P3336-21 4" x 52" ... \$ 360.00
P3336-23 6" x 52" ... \$ 420.00
P3336-24 8" x 52" ... \$ 547.00

1" ALUM SPRINKLER RISER

Top 3/4" Female Pipe Thread Bottom 1" Male Pipe Thread

AR7512 12" \$ 4.50
AR7518 18" \$ 5.25
AR7524 24" \$ 6.00
AR7536 36" \$ 7.50
AR7548 48" \$ 9.25
AR7560 60" \$10.50
AR7572 72" \$12.00



HOOK STYLE Universal

HSP330 ... 3" x 30' ... \$ 78.00
HSP340 ... 3" x 40' ... \$ 95.00
HSP430 ... 4" x 30' ... \$ 110.00
HSP440 ... 4" x 40' ... \$ 120.00
HSP530 ... 5" x 30' ... \$ 118.00

RING-LOCK Universal

RLP430 ... 4" x 30' ... \$ 115.00
RLP530 ... 5" x 30' ... \$ 142.00
RLP630 ... 6" x 30' ... \$ 182.00
RLP830 ... 8" x 30' ... \$ 264.00

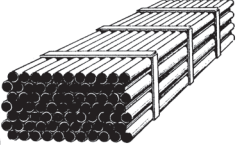
***ALL Aluminum Pipe ordered upon request**
This is a Non-Stocking Item** ***Please Call for Current Prices
***NOTE: Lead time MAY exceed 2 Month**





PVC PIPE Sch 40

All purpose PVC pipe used for plumbing, etc.

Part #	Size	Max PSI	Price/Ft.
SCH40-50	1/2"	600	\$.30
SCH40-75	3/4"	480	\$.35
SCH40-1	1"	450	\$.46
SCH40-125	1 1/4"	370	\$.55
SCH40-150	1 1/2"	330	\$.60
SCH40-2	2"	280	\$.75
SCH40-3	3"	260	\$1.55
SCH40-4	4"	220	\$2.10
SCH40-6	6"	180	\$3.90
SCH40-8	8"	160	\$5.95

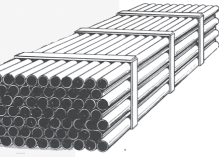
Call for current pricing



PVC UNDER GROUND PIPE

SDR 21 & 26 is a gasket type PVC pipe designed for underground mains. It is used for main lines in sprinkler systems, drip irrigation systems, etc. **10% discount on full skids.**
Please Call for Current Prices

SDR 26 Max 160 PSI			SDR 21 Max 200 PSI		
Part #	Size	Price/Ft.	Part #	Size	Price/Ft.
SDR26-3	3"	\$1.05	SDR21-2	2"	\$.63
SDR26-4	4"	\$1.60	SDR21-3	3"	\$1.28
SDR26-6	6"	\$3.32	SDR21-4	4"	\$1.98
SDR26-8	8"	\$5.75	SDR21-6	6"	\$4.08
			SDR21-8	8"	\$6.75